

Uchwyt do przyspawania UDP

Nr art.: DD1712

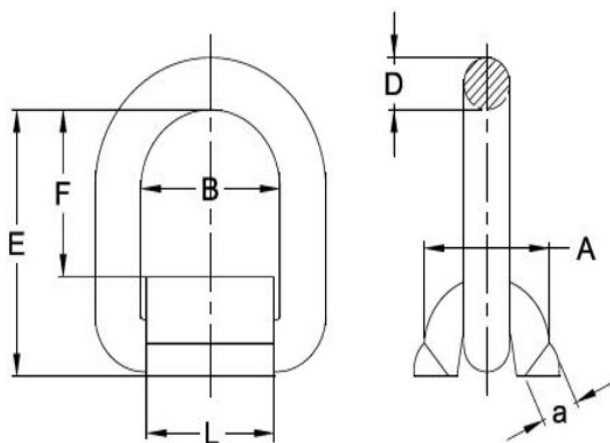







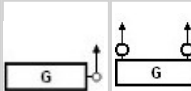

Uchwyt do przyspawania kl.8 ruchome ucho do podczepiania haków i mocowania. Może być obciążane we wszystkich kierunkach. Udźwig w zakresie 1,12 t ÷ 15,0 t. Uchwyt do przyspawania na częściach maszyn.



Model	DOR [t]	E [mm]	D [mm]	F [mm]	B [mm]	A [mm]	L [mm]	a _{min} [mm]	Waga [kg]
UDP 6-8	1,12	65	13,5	37	40	38	37	10	0,40
UDP 8-8	2,0	73	14,5	44	42	39	40	12	0,45
UDP 10-8	3,15	76	17,5	43	45	42	44	14	0,65
UDP 13-8	5,3	96	23,5	52	55	59	49	18	1,45
UDP 16-8	8,0	112	28,5	62	70	69	66	22	2,45
UDP 22-8	15,0	150	35	86	96	88	88	30	5,35

Dopuszczalne obciążenie robocze punktów mocujących przy różnych sposobach zamocowania [kg]

										
	0°	0°	0°	0°	$0^\circ-45^\circ$	$45^\circ-60^\circ$	$0^\circ-45^\circ$	$45^\circ-60^\circ$	$0^\circ-45^\circ$	$0^\circ-45^\circ$
UDP 6-8	1120	1120	2240	2240	1600	1120	2360	1700	1120	1120
UDP 8-8	2000	2000	4000	4000	2800	2000	4250	3000	2000	2000
UDP 10-8	3150	3150	6300	6300	4250	3150	6700	4750	3150	3150
UDP 13-8	5300	5300	10600	10600	7500	5300	11200	8000	5300	5300
UDP 16-8	8000	8000	16000	16000	11200	8000	17000	11800	8000	8000
UDP 22-8	15000	15000	30000	30000	21200	15000	31500	22400	15000	15000

